

1
-8
D: 38
11 L7

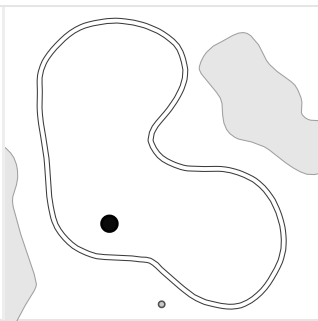

7
+1
D: 33
18 L11

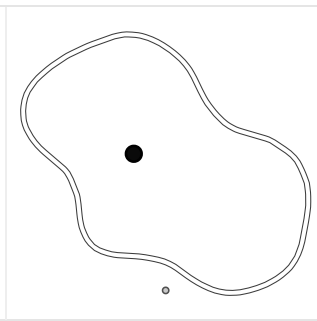

13
+2
D: 36
20 L19

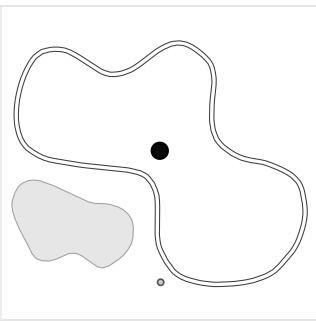

2
+1
D: 39
21 R10

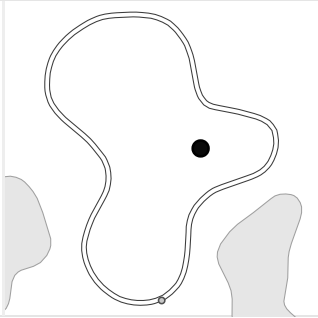

8
+3
D: 33
19 R7

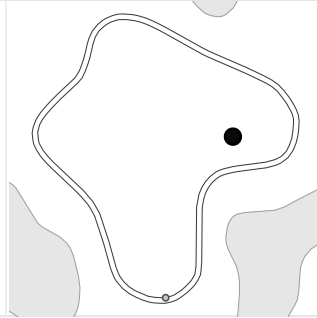

14
+6
D: 41
27 R9

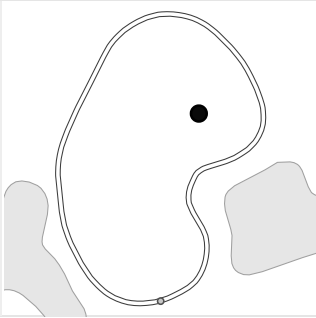

3
+9
D: 39
29 L7

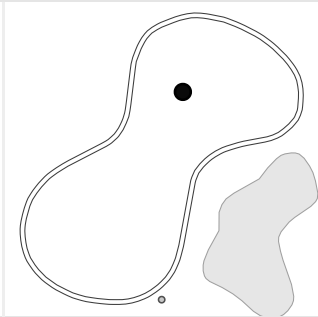

9
-12
D: 42
9

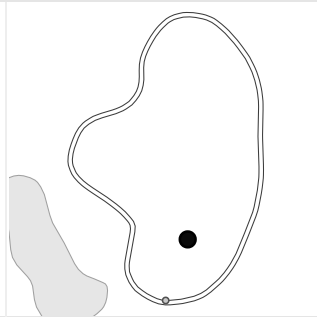

15
+10
D: 38
29 R9

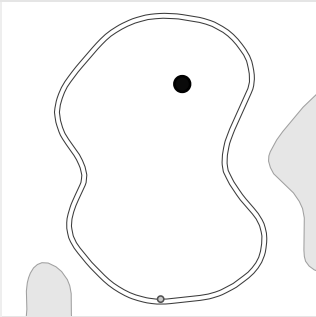

4
0
D: 32
16 R10

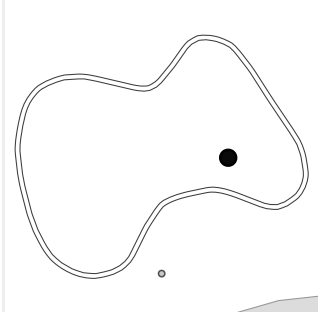

10
-4
D: 35
13

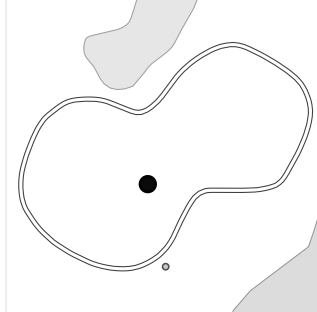

16
-14
D: 40
6 R9

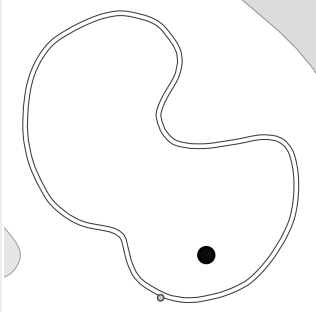

5
+10
D: 40
30 L9

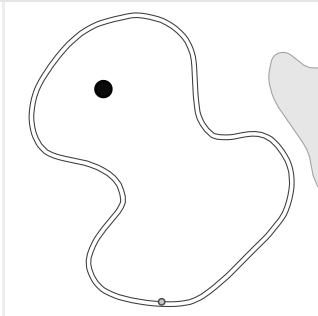

11
-7
D: 38
12 L4

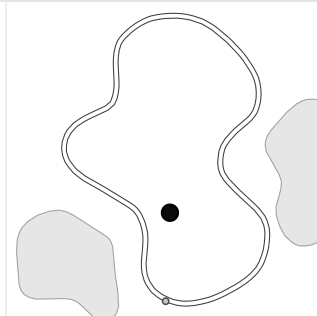

17
+7
D: 33
24 R6



6
+7
D: 35
24 L12

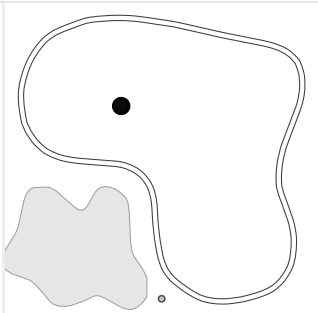

12
+8
D: 33
24 L10

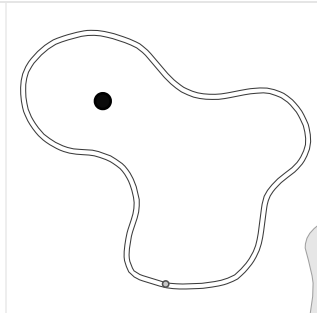

18
-13
D: 39
7 L6

